



PowerFlex 400 Adjustable Frequency AC Drive

FRN 4.xx

This Quick Start guide summarizes the basic steps needed to install, start-up and program the PowerFlex 400 Adjustable Frequency AC Drive. **The information provided Does Not replace the User Manual and is intended for qualified drive service personnel only.**

For detailed PowerFlex 400 information including EMC instructions, application considerations and related precautions refer to the PowerFlex 400 *User Manual*, Publication 22C-UM001... supplied with the drive or at www.rockwellautomation.com/literature.

General Precautions



ATTENTION: The drive contains high voltage capacitors which take time to discharge after removal of mains supply. Before working on drive, ensure isolation of mains supply from line inputs [R, S, T (L1, L2, L3)]. Wait three minutes for capacitors to discharge to safe voltage levels. Failure to do so may result in personal injury or death.

A darkened LCD display and LEDs is not an indication that capacitors have discharged to safe voltage levels.



ATTENTION: Only qualified personnel familiar with adjustable frequency AC drives and associated machinery should plan or implement the installation, start-up and subsequent maintenance of the system. Failure to comply may result in personal injury and/or equipment damage.



ATTENTION: This drive contains ESD (Electrostatic Discharge) sensitive parts and assemblies. Static control precautions are required when installing, testing, servicing or repairing this assembly. Component damage may result if ESD control procedures are not followed. If you are not familiar with static control procedures, reference A-B publication 8000-4.5.2, “Guarding Against Electrostatic Damage” or any other applicable ESD protection handbook.



ATTENTION: An incorrectly applied or installed drive can result in component damage or a reduction in product life. Wiring or application errors, such as, undersizing the motor, incorrect or inadequate AC supply, or excessive ambient temperatures may result in malfunction of the system.



ATTENTION: The bus regulator function is extremely useful for preventing nuisance overvoltage faults resulting from aggressive decelerations, overhauling loads, and eccentric loads. However, it can also cause either of the following two conditions to occur.

1. Fast positive changes in input voltage or imbalanced input voltages can cause uncommanded positive speed changes;
2. Actual deceleration times can be longer than commanded deceleration times

However, a “Stall Fault” is generated if the drive remains in this state for 1 minute. If this condition is unacceptable, the bus regulator must be disabled (see parameter A187).

Mounting Considerations

- Mount the drive upright on a flat, vertical and level surface.

Frame	Screw Size	Screw Torque
C	M5 (#10-24)	2.45-2.94 N-m (22-26 lb.-in.)
D	M8 (5/16 in.)	6.0-7.4 N-m (53.2-65.0 lb.-in.)
E	M8 (5/16 in.)	8.8-10.8 N-m (78.0-95.3 lb.-in.)
F	M10 (3/8 in.)	19.6-23.5 N-m (173.6-208.3 lb.-in.)

- Protect the cooling fan by avoiding dust or metallic particles.
- Do not expose to a corrosive atmosphere.
- Protect from moisture and direct sunlight.

Maximum Surrounding Air Temperature

Frame	Enclosure Rating	Temperature Range	Minimum Mounting Clearances
C	IP 20/UL Open-Type	-10° to 45°C (14° to 113°F)	Figure 1 : Option A
	IP 30/NEMA 1/UL Type 1 ⁽¹⁾	-10° to 45°C (14° to 113°F)	Figure 1 : Option B
	IP 20/UL Open-Type	-10° to 50°C (14° to 122°F)	Figure 1 : Option B
D, E, F	IP 30/NEMA 1/UL Type 1	-10° to 45°C (14° to 113°F)	Figure 2 :

⁽¹⁾ Frame C drives require installation of the PowerFlex 400 IP 30/NEMA 1/UL Type 1 option kit to achieve this rating.

Minimum Mounting Clearances

Figure 1: Frame C Mounting Clearances

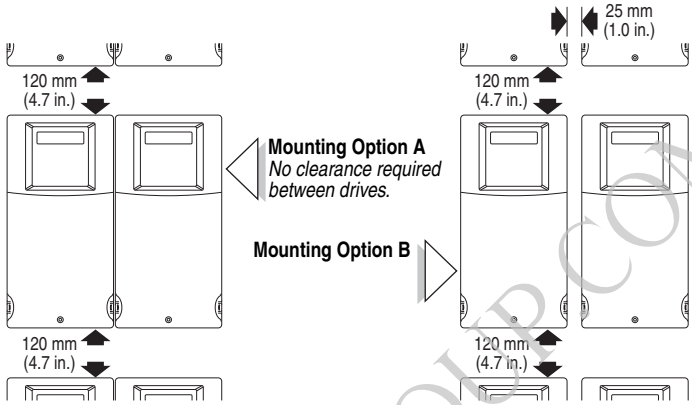
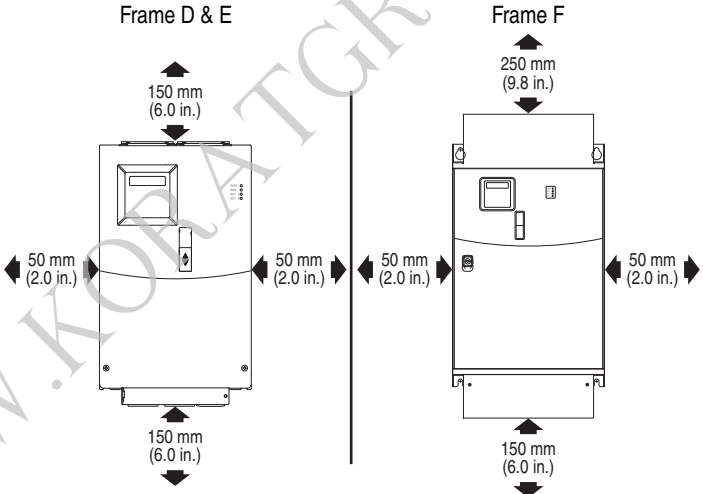
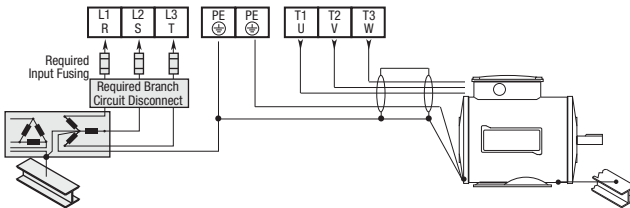

Figure 2: Frames D, E and F Mounting Clearances



General Grounding Requirements



Ungrounded Distribution Systems



ATTENTION: PowerFlex 400 drives contain protective MOVs that are referenced to ground. These devices must be disconnected if the drive is installed on an ungrounded or resistive grounded distribution system.

Phase to Ground MOV Removal

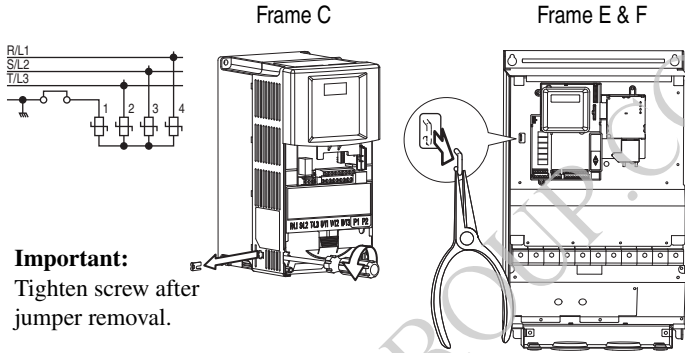

Important:
Tighten screw after jumper removal.

Note: Frame D drives do not contain a MOV to ground connection and are suitable for operation in both grounded and ungrounded distribution systems without modification.

CE Conformity

Refer to the PowerFlex 400 *User Manual* supplied with the drive for details on how to comply with the Low Voltage (LV) and Electromagnetic Compatibility (EMC) Directives.

EMC Line Filters



240V 50/60 Hz 3-Phase			480V 50/60 Hz 3-Phase		
kW	HP	Catalog Number	kW	HP	Catalog Number
2.2	3.0	22-RF034-CS	2.2	3.0	22-RF018-CS
4.0	5.0	22-RF034-CS	4.0	5.0	22-RF018-CS
5.5	7.5	22-RF034-CS	5.5	7.5	22-RF018-CS
7.5	10	22-RF034-CS	7.5	10	22-RF018-CS
11	15	22-RFD070	11	15	22-RF026-CS
15	20	22-RFD100	15	20	22-RFD036
18.5	25	22-RFD100	18.5	25	22-RFD050
22	30	22-RFD150	22	30	22-RFD050
30	40	22-RFD150	30	40	22-RFD070
37	50	22-RFD180	37	50	22-RFD100
			45	60	22-RFD100
			55	75	22-RFD150
			75	100	22-RFD180
			90	125	Consult Factory
			110	150	Consult Factory

Specifications, Fuses and Circuit Breakers

Drive Ratings

Catalog Number	Output Ratings		Input Ratings			Branch Circuit Protection				Power Dissipation
	kW (HP)	Amps 50°C	Voltage Range	kVA	Amps	Fuses (1)	140M Motor Protectors (2)(3)	Contactor	Min. Enclosure Volume ⁽⁴⁾ (in. ³)	IP20 Open Watts
200 - 240V AC – 3-Phase Input, 0 - 230V 3-Phase Output										
22C-B012N103	2.2 (3.0)	12	180-265	6.5	15.5	20	140M-F8E-C16	100-C23	5098	146
22C-B017N103	3.7 (5.0)	17.5	180-265	8.8	21	30	140M-F8E-C25	100-C37	5098	207
22C-B024N103	5.5 (7.5)	24	180-265	10.9	26.1	35	140M-F8E-C32	100-C37	5098	266
22C-B033N103	7.5 (10)	33	180-265	14.4	34.6	45	140M-F8E-C45	100-C45	5098	359
22C-B049A103	11 (15)	49	180-265	21.3	51	70	–	100-C60	–	488
22C-B065A103	15 (20)	65	180-265	28.3	68	90	–	100-C85	–	650
22C-B075A103	18.5 (25)	75	180-265	32.5	78	100	–	100-D95	–	734
22C-B090A103	22 (30)	81	180-265	38.3	92	125	–	100-D110	–	778
22C-B120A103	30 (40)	120	180-265	51.6	124	175	–	100-D180	–	1055
22C-B145A103	37 (50)	130	180-265	62.4	150	200	–	100-D180	–	1200
380 - 480V AC – 3-Phase Input, 0 - 460V 3-Phase Output										
22C-D6P0N103	2.2 (3.0)	6	340-528	6.3	7.5	10	140M-D8E-C10	100-C09	5098	105
22C-D010N103	4.0 (5.0)	10.5	340-528	10.9	13	20	140M-D8E-C16	100-C16	5098	171
22C-D012N103	5.5 (7.5)	12	340-528	11.9	14.2	20	140M-D8E-C16	100-C23	5098	200
22C-D017N103	7.5 (10)	17	340-528	15.3	18.4	25	140M-D8E-C20	100-C23	5098	267
22C-D022N103	11 (15)	22	340-528	19.2	23	30	140M-F8E-C32	100-C30	5098	329
22C-D030N103	15 (20)	27	340-528	25.8	31	40	140M-F8E-C32	100-C37	5098	435
22C-D038A103	18.5 (25)	38	340-528	33.3	40	50	140M-F8E-C45	100-C60	9086	606
22C-D045A103	22 (30)	45.5	340-528	39.1	47	60	–	100-C60	–	738
22C-D060A103	30 (40)	54	340-528	53.3	64	80	–	100-C85	–	664
22C-D072A103	37 (50)	72	340-528	60.7	73	100	–	100-C85	–	1019
22C-D088A103	45 (60)	88	340-528	74.9	90	125	–	100-D110	–	1245
22C-D105A103	55 (75)	105	340-528	89	107	150	–	100-D140	–	1487
22C-D142A103	75 (100)	128	340-528	124.8	150	200	–	100-D180	–	2043
22C-D170A103	90 (125)	170	340-528	142	170	250	–	100-D250	–	2617
22C-D208A103	110 (150)	208	340-528	167	200	250	–	100-D250	–	3601

- (1) Recommended Fuse Type: UL Class J, CC, T or Type BS88; 600V (550V) or equivalent.
- (2) The AIC ratings of the Bulletin 140M Motor Protector Circuit Breakers may vary. See [Bulletin 140M Motor Protection Circuit Breakers Application Ratings](#).
- (3) Manual Self-Protected (Type E) Combination Motor Controller, UL listed for 208 Wye or Delta, 240 Wye or Delta, 480Y/277 or 600Y/347. Not UL listed for use on 480V or 600V Delta/Delta, corner ground, or high-resistance ground systems.
- (4) When using a Manual Self-Protected (Type E) Combination Motor Controller, the drive must be installed in a ventilated or non-ventilated enclosure with the minimum volume specified in this column. Application specific thermal considerations may require a larger enclosure.

Category	Specification	
Agency Certification		Listed to UL508C and CAN/CSA-22.2 Listed to UL508C for plenums
		Certified to AS/NZS, 1997 Group 1, Class A
		Marked for all applicable European Directives EMC Directive (89/336) EN 61800-3, EN 50081-1, EN 50082-2 Low Voltage Directive (73/23/EEC) EN 50178, EN 60204
	The drive is also designed to meet the appropriate portions of the following specifications: NFPA 70 - US National Electrical Code NEMA ICS 3.1 - Safety standards for Construction and Guide for Selection, Installation and Operation of Adjustable Speed Drive Systems. IEC 146 - International Electrical Code.	
Protection	Bus Overvoltage Trip:	200-240V AC Input: 405V DC bus voltage (equivalent to 290V AC incoming line) 380-460V AC Input: 810V DC bus voltage (equivalent to 575V AC incoming line)
	Bus Undervoltage Trip:	200-240V AC Input: 210V DC bus voltage (equivalent to 150V AC incoming line) 380-480V AC Input: 390V DC bus voltage (equivalent to 275V AC incoming line)
	Power Ride-Thru:	100 milliseconds
	Logic Control Ride-Thru:	0.5 seconds minimum, 2 seconds typical
	Electronic Motor Overload Protection:	Provides class 10 motor overload protection according to NEC article 430 and motor over-temperature protection according to NEC article 430.126 (A) (2). UL 508C File 29572.
	Overcurrent:	180% hardware limit, 220% instantaneous fault
	Ground Fault Trip:	Phase-to-ground on drive output
Short Circuit Trip:	Phase-to-phase on drive output	
Electrical	Efficiency:	97.5% at rated amps, nominal line voltage
Control	Output Frequency:	0-320 Hz (programmable)
Control Inputs	Digital:	Quantity: (3) Semi-programmable (4) Programmable Type Source Mode (SRC): 18-24V = ON, 0-6V = OFF Sink Mode (SNK): 0-6V = ON, 18-24V = OFF
	Analog:	Quantity: (1) Isolated, -10 to 10V or 4-20mA (1) Non-isolated, 0 to 10V or 4-20mA Specification Resolution: 10-bit 0 to 10V DC Analog: 100k ohm input impedance 4-20mA Analog: 250 ohm input impedance External Pot: 1-10k ohm, 2 Watt minimum
	Relay:	Quantity: (2) Programmable Form C Specification Resistive Rating: 3.0A at 30V DC, 3.0A at 125V, 3.0A at 240V AC Inductive Rating: 0.5A at 30V DC, 0.5A at 125V, 0.5A at 240V AC
Control Outputs	Optional Relay Card:	Quantity: (6) Optional Programmable Form A (Drive Frames D, E & F Only) Specification Resistive Rating: 0.1A at 30V DC Class II circuits, 3.0A at 125V, 3.0A at 240V AC Inductive Rating: 0.1A at 30V DC Class II circuits, 3.0A at 125V, 3.0A at 240V AC
	Opto:	Quantity: (1) Programmable Specification: 30V DC, 50mA Non-inductive
	Analog:	Quantity: (2) Non-Isolated, 0-10V or 4-20mA Specification Resolution: 10-bit 0 to 10V DC Analog: 1k ohm minimum 4-20mA Analog: 525 ohm maximum

Power Wiring

Figure 3: Power Terminal Blocks

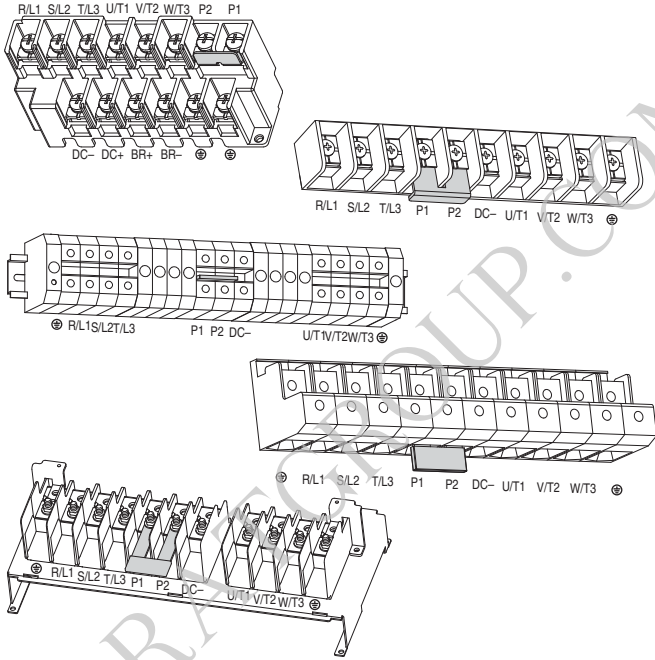

Terminal ⁽¹⁾	Description
R/L1, S/L2, T/L3	3-Phase Input
U/T1	To Motor U/T1
V/T2	To Motor V/T2
W/T3	To Motor W/T3
	DC Bus Inductor Connection
P2, P1	Drives are shipped with a jumper between Terminals P2 and P1. Remove this jumper only when a DC Bus Inductor will be connected. Drive will not power up without a jumper or inductor connected.
DC-, DC+	DC Bus Connection (Frame C Drives)
P2, DC-	DC Bus Connection (Frame D, E, and F Drives)
BR+, BR-	Not Used
⊕	Safety Ground - PE

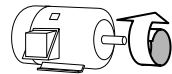

Switch any two motor leads to change forward direction.



⁽¹⁾ **Important:** Terminal screws may become loose during shipment. Ensure that all terminal screws are tightened to the recommended torque before applying power to the drive.

Power Terminal Block Specifications

Frame	Maximum Wire Size ⁽¹⁾	Minimum Wire Size ⁽¹⁾	Recommended Torque
C	8.4 mm ² (8 AWG)	1.3 mm ² (16 AWG)	2.9 N-m (26 lb.-in.)
D	33.6 mm ² (2 AWG)	8.4 mm ² (8 AWG)	5.1 N-m (45 lb.-in.)
E 480V 37-45 kW (50-60 HP)	33.6 mm ² (2 AWG)	3.5 mm ² (12 AWG)	5.6 N-m (49.5 lb.-in.)
E 240V 30-37 kW (40-50 HP) 480V 55-75 kW (75-100 HP)	107.2 mm ² (4/0 AWG)	53.5 mm ² (1/0 AWG)	19.5 N-m (173 lb.-in.)
F	152.5 mm ² (300 MCM)	85.0 mm ² (3/0 AWG)	19.5 N-m (173 lb.-in.)

⁽¹⁾ Maximum/minimum sizes that the terminal block will accept - these are not recommendations. If national or local codes require sizes outside this range, lugs may be used.

Important: Frame C, D, and F drives utilize a finger guard over the power wiring terminals. Replace the finger guard when wiring is complete.

Refer to the PowerFlex 400 *User Manual* for maximum power cable length recommendations.

Input Power Conditions

Input Power Condition	Corrective Action
Low Line Impedance (less than 1% line reactance)	<ul style="list-style-type: none"> • Install Line Reactor⁽¹⁾ • or Isolation Transformer
Line has power factor correction capacitors	<ul style="list-style-type: none"> • Install Line Reactor⁽¹⁾ • or Isolation Transformer
Line has frequent power interruptions	
Line has intermittent noise spikes in excess of 6000V (lightning)	
Phase to ground voltage exceeds 125% of normal line to line voltage	<ul style="list-style-type: none"> • Remove MOV jumper to ground (Frame C, E & F drives only) • or Install Isolation Transformer with grounded secondary if necessary
Ungrounded distribution system	

⁽¹⁾ Refer to the PowerFlex 400 *User Manual* for accessory ordering information.

I/O Wiring Recommendations

Wire Type(s)	Description	Minimum Insulation Rating
Belden 8760/9460 (or equiv.)	0.8 mm ² (18 AWG), twisted pair, 100% shield with drain.	300V 60 degrees C (140 degrees F)
Belden 8770 (or equiv.)	0.8 mm ² (18 AWG), 3 conductor, shielded for remote pot only.	

- (1) If the wires are short and contained within a cabinet which has no sensitive circuits, the use of shielded wire may not be necessary, but is always recommended.

I/O Terminal Block Specifications

Frame	Maximum Wire Size ⁽²⁾	Minimum Wire Size ⁽²⁾	Torque
C, D, E, F	1.3 mm ² (16 AWG)	0.13 mm ² (26 AWG)	0.5-0.8 N-m (4.4-7 lb.-in.)

- (2) Maximum/minimum sizes that the terminal block will accept - these are not recommendations.

Refer to the PowerFlex 400 *User Manual* for maximum control cable length recommendations.

Control Terminal Block

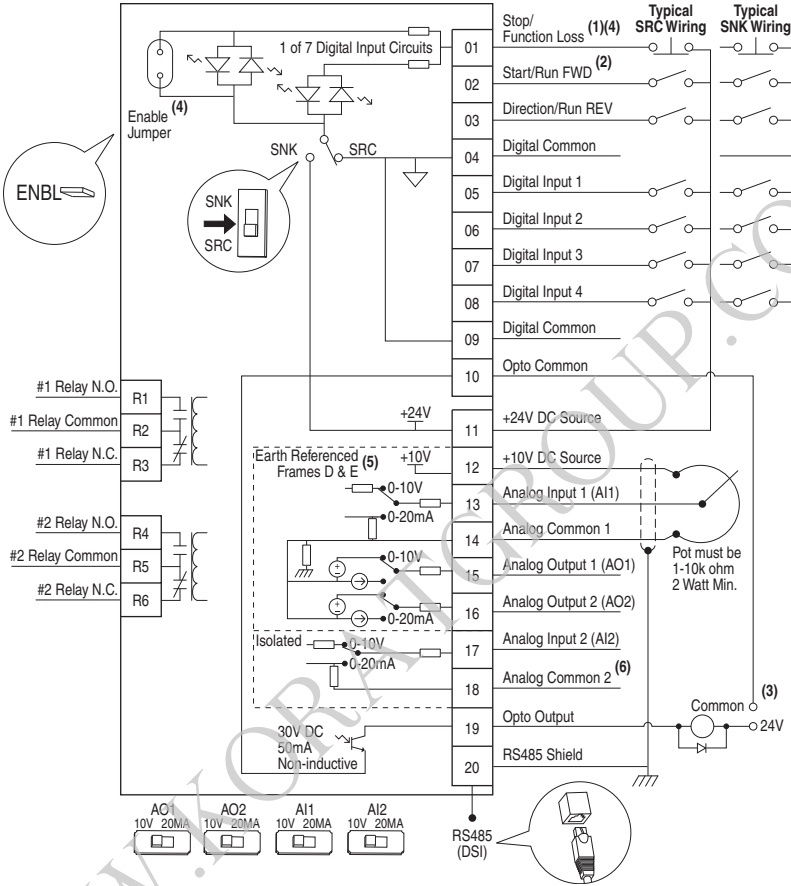

(1) **Important:** I/O Terminal 01 is always a coast to stop input except when P036 [Start Source] is set to option 1 "3-Wire" or 6 "2-W Lv/Enbl". In three wire control, I/O Terminal 01 is controlled by P037 [Stop Mode]. All other stop sources are controlled by P037 [Stop Mode].

Important: The drive is shipped with a jumper installed between I/O Terminals 01 and 11. Remove this jumper when using I/O Terminal 01 as a stop or enable input.

(2) Two wire control shown. For three wire control use a momentary input $\text{---} \text{---} \text{---}$ on I/O Terminal 02 to command a start. If reverse is enabled by A166, use a maintained input $\text{---} \text{---} \text{---}$ for I/O Terminal 03 to change direction.

(3) When using an opto output with an inductive load such as a relay, install a recovery diode parallel to the relay as shown, to prevent damage to the output.

(4) When the ENBL enable jumper is removed, I/O Terminal 01 will always act as a hardware enable, causing a coast to stop without software interpretation.

(5) Most I/O terminals labeled "Common" are not referenced to the safety ground (PE) terminal and are designed to greatly reduce common mode interference. On Frame D and E drives, Analog Common 1 is referenced to ground.

(6) Common for Analog Input 2 (AI2). Electronically isolated from digital I/O and opto output. Not to be used with Analog Input 1 (AI1), Analog Output 1 (AO1) or Analog Output 2 (AO2). With Analog Input 2, provides one fully isolated analog input channel.

P036 [Start Source]	Stop	I/O Terminal 01 Stop
Keypad	Per P037	Coast
3-Wire	Per P037	Per P037 ⁽⁴⁾
2-Wire	Per P037	Coast
RS485 Port	Per P037	Coast

Control I/O Terminal Designations

No.	Signal	Default	Description	Param.
01	Stop ⁽¹⁾ / Function Loss	Coast	Factory installed jumper or a normally closed input must be present for the drive to start. Program with P036 [Start Source].	P036 ⁽¹⁾
02	Start/Run FWD	–	HAND Mode: Command comes from Integral Keypad. AUTO Mode: I/O Terminal 02 is active. Program with P036 [Start Source].	P036, P037
03	Direction/Run REV	Rev Disabled	To enable reverse operation, program with A166 [Reverse Disable]. Program with P036 [Start Source].	P036, P037, A166
04	Digital Common	–	For digital inputs. Tied to I/O Terminal 09. Electronically isolated with digital inputs from analog I/O and opto output.	
05	Digital Input 1	Purge ⁽²⁾	Program with T051 [Digital In1 Sel].	T051
06	Digital Input 2	Local	Program with T052 [Digital In2 Sel].	T052
07	Digital Input 3	Clear Fault	Program with T053 [Digital In3 Sel].	T053
08	Digital Input 4	Comm Port	Program with T054 [Digital In4 Sel].	T054
09	Digital Common	–	For digital inputs. Tied to I/O Terminal 04. Electronically isolated with digital inputs from analog I/O and opto output.	
10	Opto Common	–	For opto-coupled outputs. Electronically isolated with opto output from analog I/O and digital inputs.	
11	+24V DC	–	Drive supplied power for digital inputs. Referenced to Digital Common. Max. Output: 100mA.	
12	+10V DC	–	Drive supplied power for 0-10V external potentiometer. Referenced to Analog Common. Max. Output: 15mA.	P038
13	Analog Input 1	0-10V	External 0-10V (unipolar), 0-20mA or 4-20mA input supply or potentiometer wiper. Default input is 0-10V. For current (mA) input, set AI1 DIP Switch to 20mA. Program with T069 [Analog In 1 Sel]. Input Impedance: 100k ohm (Voltage Mode) 250 ohm (Current Mode)	T069, T070, T071, T072
14	Analog Common 1	–	Common for Analog Input 1 and Analog Output 1 and 2. Electrically isolated from digital I/O and opto output.	
15	Analog Output 1	OutFreq 0-10	Default analog output is 0-10V. For current (mA) value, set AO1 DIP Switch to 20mA. Program with T082 [Analog Out1 Sel]. Maximum Load: 4-20mA = 525 ohm (10.5V) 0-10V = 1k ohm (10mA)	P038, T051-T054, A152
16	Analog Output 2	OutCurr 0-10	Default analog output is 0-10V. For a current (mA) value, set AO2 DIP Switch to 20mA. Program with T085 [Analog Out2 Sel]. Maximum Load: 4-20mA = 525 ohm (10.5V) 0-10V = 1k ohm (10mA)	T082, T084, T085, T086, T087
17	Analog Input 2	0-10V	Optically isolated external 0-10V (unipolar), ±10V (bipolar), 0-20mA or 4-20mA input supply or potentiometer wiper. Default input is 0-10V. For current (mA) input, set AI2 DIP Switch to 20mA. Program with T073 [Analog In 2 Sel]. Input Impedance: 100k ohm (Voltage Mode) 250 ohm (Current Mode)	T073, T074, T075, T076
18	Analog Common 2	–	For Analog Input 2. Electronically isolated from digital I/O and opto output. With Analog Input 2, provides one fully isolated analog input channel.	
19	Opto Output	At Frequency	Program with T065 [Opto Out Sel].	T065, T066, T068
20	RS485 (DSI) Shield	–	Terminal connected to Safety Ground - PE when using the RS485 (DSI) Communication Port.	

(1) See Footnotes (1) and (4) on previous page.

(2) See the *User Manual* for **Important** information regarding Stop commands and the [Digital Inx Sel] Purge option.

Relay Terminal Designations and DIP Switches

No.	Signal	Default	Description	Param.
R1	#1 Relay N.O.	Ready/Fault	Normally open contact for No. 1 output relay.	T055
R2	#1 Relay Common	-	Common for output relay.	
R3	#1 Relay N.C.	Ready/Fault	Normally closed contact for No. 1 output relay.	T055
R4	#2 Relay N.O.	Motor Running	Normally open contact for No. 2 output relay.	T060
R5	#2 Relay Common	-	Common for output relay.	
R6	#2 Relay N.C.	Motor Running	Normally closed contact for No. 2 output relay.	T060
Selection DIP Switches: Analog Input (AI1 & AI2) Analog Output (AO1 & AO2)		0-10V	Sets analog output to either voltage or current. Settings must match: AI1 & T069 [Analog In 1 Sel] AI2 & T073 [Analog In 2 Sel] AO1 & T082 [Analog Out1 Sel] AO2 & T085 [Analog Out2 Sel]	
Sink/Source DIP Switch		Source (SRC)	Inputs can be wired as Sink (SNK) or Source (SRC) via DIP Switch setting.	

Figure 4: User Installed Auxiliary Relay Card (Frames D, E, & F Only)

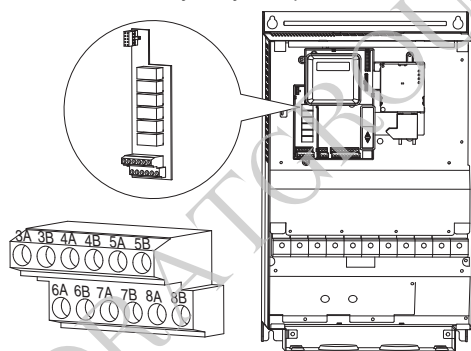

Important: If using auxiliary motor control, ensure that wiring and parameter configuration are correct before wiring contactor outputs. All relays on the Auxiliary Relay Card will energize on power-up by default. Failure to verify proper wiring and parameter configuration can result in improper motor operation or drive damage. Refer to Appendix D for more details.

User Installed Relay Board Terminal Designations

No.	Signal	Default	Description	Param.
3A	#3 Relay N.O.	Ready/Fault	Normally open contact for Number 3 Output Relay	R221
3B	#3 Relay Common	-	Common for Number 3 Output Relay	
4A	#4 Relay N.O.	Ready/Fault	Normally open contact for Number 4 Output Relay	R224
4B	#4 Relay Common	-	Common for Number 4 Output Relay	
5A	#5 Relay N.O.	Ready/Fault	Normally open contact for Number 5 Output Relay	R227
5B	#5 Relay Common	-	Common for Number 5 Output Relay	
6A	#6 Relay N.O.	Ready/Fault	Normally open contact for Number 6 Output Relay	R230
6B	#6 Relay Common	-	Common for Number 6 Output Relay	
7A	#7 Relay N.O.	Ready/Fault	Normally open contact for Number 7 Output Relay	R233
7B	#7 Relay Common	-	Common for Number 7 Output Relay	
8A	#8 Relay N.O.	Ready/Fault	Normally open contact for Number 8 Output Relay	R236
8B	#8 Relay Common	-	Common for Number 8 Output Relay	

Prepare For Drive Start-Up



ATTENTION: Power must be applied to the drive to perform the following start-up procedures. Some of the voltages present are at incoming line potential. To avoid electric shock hazard or damage to equipment, only qualified service personnel should perform the following procedure. Thoroughly read and understand the procedure before beginning. If an event does not occur while performing this procedure, **Do Not Proceed. Remove All Power** including user supplied control voltages. User supplied voltages may exist even when main AC power is not applied to the drive. Correct the malfunction before continuing.

Before Applying Power to the Drive

- 1. Confirm that all inputs are connected to the correct terminals and are secure.
- 2. Verify that AC line power at the disconnect device is within the rated value of the drive.
- 3. Verify that any digital control power is 24 volts.
- 4. Verify that the Sink (SNK)/Source (SRC) Setup DIP Switch is set to match your control wiring scheme.

Important: The default control scheme is Source (SRC). The Stop terminal is jumpered (I/O Terminals 01 and 11) to allow starting from the keypad. If the control scheme is changed to Sink (SNK), the jumper must be removed from I/O Terminals 01 and 11 and installed between I/O Terminals 01 and 04.

- 5. Verify that the Stop input is present or the drive will not start.

Important: If I/O Terminal 01 is used as a stop input, the jumper between I/O Terminals 01 and 11 must be removed.

- 6. Verify that the Analog I/O DIP Switches are set to 10 volts.

Applying Power to the Drive

- 7. Apply AC power and control voltages to the drive.
- 8. Familiarize yourself with the integral keypad features before setting any Program Group parameters.

Start, Stop, Direction and Speed Control

Factory default parameter values allow the drive to be controlled from the integral keypad. No programming is required to start, stop, and control speed directly from the integral keypad.

If a fault appears on power up, refer to page 25 for an explanation of the fault code. For complete troubleshooting information, refer to the PowerFlex 400 *User Manual* supplied with the drive.

Integral Keypad







Operator Keys

Key	Name	Description
	Escape	Back one step in programming menu. Cancel a change to a parameter value and exit Program Mode.
	Select	Advance one step in programming menu. Select a digit when viewing parameter value.
	Up Arrow Down Arrow	Scroll through groups and parameters. Increase/decrease the value of a flashing digit.
	Enter	Advance one step in programming menu. Save a change to a parameter value.
	Digital Speed Increment and Decrement Arrows	Used to control speed of drive. Default is active. Control is activated by parameter P038 [Speed Reference] or P042 [Auto Mode].
	Run/Start & Hand ⁽¹⁾	Used to start the drive. Default is Hand mode as controlled by parameter P042 [Auto Mode]. Control is activated by parameter P036 [Start Source] or P042 [Auto Mode].
	Auto ⁽¹⁾	Used to select Auto control mode. Controlled by parameter P042 [Auto Mode].
	Stop/Off	Used to stop the drive or clear a fault. This key is always active. Controlled by parameter P037 [Stop Mode].









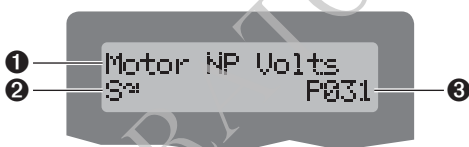













⁽¹⁾ **Important:** Certain digital input settings can override drive operation. Refer to the PowerFlex 400 User Manual for details.

LED Status Indicators

LED		LED State	Description
	Program Status	Steady Red	Indicates parameter value can be changed. Selected digit will flash.
	Fault Status	Flashing Red	Indicates that the drive is faulted.
	Speed Status	Steady Green	Indicates that the digital speed control keys are enabled.
	Hand Status	Steady Green	Indicates that the Run/Start key is enabled.
	Auto Status	Steady Yellow	Indicates that the drive is in Auto mode.

LCD Display



No.	Description									
1	Parameter Name									
2	<p>Run/Stop Status: S² & S² = Stopped / R² & R² = Running R² or R² flashes to indicate that the drive is stopping, but is still decelerating. R² or R² flashes when DC Injection is commanded.</p> <p>Direction Indication: The Direction Arrow  &  indicates the commanded direction of rotation. If the Arrow is flashing, the drive has been commanded to change direction, but is still decelerating.</p> <p>Sleep Mode Indication: R² or R² flashes to indicate that the drive is in sleep mode.</p>									
3	<p>Parameter Group and Number:</p> <table border="0"> <tr> <td> = Basic Display</td> <td> = Basic Program</td> <td> = Terminal Block</td> </tr> <tr> <td> = Communications</td> <td> = Advanced Program</td> <td> = Aux Relay Card</td> </tr> <tr> <td> = Advanced Display</td> <td></td> <td></td> </tr> </table>	 = Basic Display	 = Basic Program	 = Terminal Block	 = Communications	 = Advanced Program	 = Aux Relay Card	 = Advanced Display		
 = Basic Display	 = Basic Program	 = Terminal Block								
 = Communications	 = Advanced Program	 = Aux Relay Card								
 = Advanced Display										



4	Fault Indication and Fault Number
5	Fault Name

Keypad Hand-Off-Auto Functions

Parameter P042 [Auto Mode] defines the operation mode of the control keys on the integral keypad. Hand-Off-Auto is the default operation mode for PowerFlex 400 drives. For detailed information on other operation modes, refer to the PowerFlex 400 *User Manual* supplied with the drive.

Hand-Off-Auto Mode











In HAND mode:

- Control keys operate as Hand-Off-Auto.
- Start command and speed reference come from the integral keypad Start/Hand and Digital Speed Increment and Decrement keys.
- Auto key switches control from HAND mode to AUTO mode in a bumpless transfer as long as there is an active Run command.

In AUTO mode:

- Auto key LED is illuminated.
- Start command is defined by P036 [Start Source].
- Speed Reference command is defined by P038 [Speed Reference].
- Start/Hand key switches control to the integral keypad in a bumpless transfer and switches the speed reference to the integral keypad.
- Stop key stops the drive and the drive switches to HAND mode.

**Table 4.A P042 [Auto Mode] = 1 “Hnd-Off-Auto” (Default)
T051-T054 [Digital Inx Sel] ≠ 2 “Auto Mode” or 3 “Local”**

Key	HAND Mode		AUTO Mode	
	LED	Key Function	LED	Key Function
	On 	Starts drive. Runs according to Speed Increment/ Decrement keys.	On 	Changes to HAND Mode and Starts drive. Runs according to Speed Increment/ Decrement keys.
	On 	Changes speed.	Off 	Not active. Keys are only active if P038 [Speed Source] = 0 “Drive Pot”.
	Off 	Changes to AUTO Mode.	On 	Not active.
	N/A	Stops drive.	N/A	Changes to HAND Mode and Stops drive.

Viewing and Editing Parameters

The following is an example of basic integral keypad and display functions. This example provides basic navigation instructions and illustrates how to program the first Basic Program Group parameter.

Step	Key(s)	Example Displays
1. When power is applied, the last user-selected Basic Display Group parameter number is displayed with flashing characters. The display then defaults to that parameter's current value. (Example shows the value of b001 [Output Freq] with the drive stopped.)		
2. Press the Up Arrow or Down Arrow to scroll through the Basic Display Group parameters. (Only in Display Groups)	or	
3. Press Esc once to display the Basic Display Group parameter number shown on power-up. The parameter number will flash.		
4. Press Esc again to enter the group menu. The group menu letter will flash.		
5. Press the Up Arrow or Down Arrow to scroll through the group menu (b, P, T, C, A and d).	or	
6. Press Enter or Sel to enter a group. The right digit of the last viewed parameter in that group will flash.	or	
7. Press the Up Arrow or Down Arrow to scroll through the parameters that are in the group.	or	
8. Press Enter or Sel to view the value of a parameter. If you do not want to edit the value, press Esc to return to the parameter number.	or	
9. Press Enter or Sel to enter program mode to edit the parameter value. The right digit will flash and the Program LED will illuminate if the parameter can be edited.	or	
10. If desired, press Sel to move from digit to digit or bit to bit. The digit or bit that you can change will flash.		
11. Press the Up Arrow or Down Arrow to change the parameter value.	or	
12. Press Esc to cancel a change. The digit will stop flashing, the previous value is restored and the Program LED will turn off.		
Or		
Press Enter to save a change. The digit will stop flashing and the Program LED will turn off.		
13. Press Esc to return to the parameter list. Continue to press Esc to back out of the programming menu.		
If pressing Esc does not change the display, then b001 [Output Freq] is displayed. Press Enter or Sel to enter the last group menu viewed.		

Basic Display Group Parameters

The Basic Program Group contains the most commonly changed parameters.

No.	Parameter	Min/Max	Display/Options
b001	[Output Freq]	0.00/[Maximum Freq]	0.01 Hz
b002	[Commanded Freq]	0.00/[Maximum Freq]	0.01 Hz
b003	[Output Current]	0.0/(Drive Amps × 2)	0.1 Amps
b004	[Output Voltage]	0/510	1 VAC
b005	[DC Bus Voltage]	0/820	1 VDC
b006	[Drive Status]	0/1 (1 = Condition True)	Bit 4 Decelerating Bit 3 Accelerating Bit 2 Forward Bit 1 Running
b007	[Fault 1 Code]	0/122	1
b008	[Process Display]	0.00/9999.99	0.01
b010	[Output Power]	0.0/999.9 kW	0.1 kW
b011	[Elapsed MWh]	0/3276.7 MWh	0.1 MWh
b012	[Elapsed Run Time]	0/9999 Hrs	1 = 10 Hrs
b013	[Torque Current]	0.0/(Drive Amps × 2)	0.1 Amps
b014	[Drive Temp]	0/120 degC	1 degC
b015	[Elapsed kWh]	0.0/100.0 kWh	0.1 kWh

Smart Start-Up with Basic Program Group

The PowerFlex 400 is designed so that start up is simple and efficient. The Program Group contains the most commonly used parameters.

= Stop drive before changing this parameter.

No.	Parameter	Min/Max	Display/Options	Default
P031	[Motor NP Volts] <input type="radio"/> Set to the motor nameplate rated volts.	20/Drive Rated Volts	1 VAC	Based on Drive Rating
P032	[Motor NP Hertz] <input type="radio"/> Set to the motor nameplate rated frequency.	15/320 Hz	1 Hz	60 Hz
P033	[Motor OL Current] Set to the maximum allowable motor current.	0.0/(Drive Amps × 2)	0.1 Amps	Based on Drive Rating
P034	[Minimum Freq] Sets the lowest frequency the drive will output continuously.	0.0/320.0 Hz	0.1 Hz	0.0 Hz
P035	[Maximum Freq] <input type="radio"/> Sets the highest frequency the drive will output.	0.0/320.0 Hz	0.1 Hz	60.0 Hz
P036	[Start Source] <input type="radio"/> Sets the control scheme used to start the drive when in Auto/Remote mode.	0/6	0 = "Keypad" 1 = "3-Wire" 2 = "2-Wire" 3 = "2-W Lvl Sens" 4 = "2-W Hi Speed" 5 = "Comm Port" 6 = "2-W Lvl/Enbl"	3
P037	[Stop Mode] Active stop mode for all stop sources [e.g. keypad, run forward (I/O Terminal 02), run reverse (I/O Terminal 03), RS485 port] except as noted below. Important: I/O Terminal 01 is always a coast to stop input except when P036 [Start Source] is set for "3-Wire" control. When in three wire control, I/O Terminal 01 is controlled by P037 [Stop Mode].	0/7	0 = "Ramp, CF" ⁽¹⁾ 1 = "Coast, CF" ⁽¹⁾ 2 = "DC Brake, CF" ⁽¹⁾ 3 = "DCBrkAuto, CF" ⁽¹⁾ 4 = "Ramp" 5 = "Coast" 6 = "DC Brake" 7 = "DC BrakeAuto" ⁽¹⁾ Stop input also clears active fault.	0

= Stop drive before changing this parameter.

No.	Parameter	Min/Max	Display/Options	Default
P038	[Speed Reference] Sets the source of the speed reference to the drive. Important: When T051 – T054 [Digital Inx Sel] is set to option 1, 2, 3, 4, 5, 8, 14, 15, 16 or 17 and the digital input is active, or if A152 [PID Ref Sel] is not set to option 0, the speed reference commanded by this parameter will be overridden. Refer to Chapter 1 of the PowerFlex 400 User Manual for details.	0/5	0 = "Drive Keypad" 1 = "InternalFreg" 2 = "Analog In 1" 3 = "Analog In 2" 4 = "Preset Freq" 5 = "Comm Port"	2
P039	[Accel Time 1] Sets the rate of accel for all speed increases.	0.00/600.00 Secs	0.01 Secs	20.00 Secs
P040	[Decel Time 1] Sets the rate of decel for all speed decreases.	0.00/600.00 Secs	0.01 Secs	20.00 Secs
P041	[Reset To Defaults] <input type="radio"/> Resets all parameter values to factory defaults.	0/1	0 = "Ready/Idle" 1 = "Factory Rset"	0
P042	[Auto Mode] <input type="radio"/> Determines the operation of the "Auto" key on the integral keypad.	0/3	0 = "No Function" 1 = "Hnd-Off-Auto" 2 = "Local/Remote" 3 = "Auto/Manual"	1
P043	[Motor OL Ret] Enables/disables the Motor Overload Retention function.	0/1	0 = "Disabled" 1 = "Enabled"	0 = "Disabled"

Terminal Block Group Parameters

No.	Parameter	Min/Max	Display/Options	Default		
T051	[Digital In1 Sel] I/O Terminal 05	0/36	0 = "Not Used"	14 = "Anlg1 InCtrl"	1	
T052	[Digital In2 Sel] I/O Terminal 06		1 = "Purge"	15 = "Anlg2 InCtrl"		
T053	[Digital In3 Sel] I/O Terminal 07		2 = "Auto Mode"	16 = "MOP Up"		
T054	[Digital In4 Sel] <input type="radio"/> I/O Terminal 08		3 = "Local"	17 = "MOP Down"		
			4 = "Comm Port"	18 = "Acc & Dec 2"	10	
			5 = "PID Disable"	19 = "Current Lmt2"	4	
			6 = "PID Hold"	20 = "Force DC"		
			7 = "PID Reset"	21 = "Mtr l-Lock 1"		
			8 = "Preset Freq"	22 = "Mtr l-Lock 2"		
			9 = "Aux Fault"	23 = "Mtr l-Lock 3"		
			10 = "Clear Fault"	24 = "Mtr l-Lock 4"		
			11 = "RampStop,CF"	25 = "Cmd Reverse"		
			12 = "CoastStop,CF"	31 = "Logic In 1"		
			13 = "DCInjStop,CF"	32 = "Logic In 2"		
				36 = "Damper Input"		
T055	[Relay Out1 Sel]	0/23	0 = "Ready/Fault"	9 = "Above Anlg 2"		0
T060	[Relay Out2 Sel]		1 = "At Frequency"	10 = "Above PF Ang"		
			2 = "MotorRunning"	11 = "Anlg In Loss"		2
			3 = "Hand Active"	12 = "ParamControl"		
			4 = "Motor Overrid"	13 = "Retries Exst"		
			5 = "Ramp Reg"	14 = "NonRec Fault"		
			6 = "Above Freq"	15 = "Reverse"		
			7 = "Above Cur"	16 = "Logic In 1"		
			8 = "Above DCVolt"	17 = "Logic In 2"		
				23 = "Aux Motor"		
T056	[Relay Out1 Level]	0.0/9999	0.1	0.0		
T058	[Relay 1 On Time]	0.0/600.0 Secs	0.1 Secs	0.0 Secs		
T059	[Relay 1 Off Time]	0.0/600.0 Secs	0.1 Secs	0.0 Secs		
T061	[Relay Out2 Level]	0.0/9999	0.1	0.0		
	T060 Setting	T061 Min/Max				
	6	0/320 Hz				
	7	0/180%				
	8	0/815 Volts				
	9	0/100%				
	10	1/180 degs				
	12	0/1				
T063	[Relay 2 On Time]	0.0/600.0 Secs	0.1 Secs	0.0 Secs		

No.	Parameter	Min/Max	Display/Options	Default
T064	[Relay 2 Off Time]	0.0/600.0 Secs	0.1 Secs	0.0 Secs
T065	[Opto Out Sel]	0/17	0 = "Ready/Fault" 1 = "At Frequency" 2 = "MotorRunning" 3 = "Hand Active" 4 = "Motor Overrid" 5 = "Ramp Reg" 6 = "Above Freq" 7 = "Above Cur" 8 = "Above DCVolt" 9 = "Above Anlg 2" 10 = "Above PF Anlg" 11 = "Anlg In Loss" 12 = "ParamControl" 13 = "Retries Exst" 14 = "NonRec Fault" 15 = "Reverse" 16 = "Logic In 1" 17 = "Logic In 2"	1
T066	[Opto Out Level]	0.0/9999	0.1	0.0
	T066 Setting	T066 Min/Max		
	6	0/400 Hz		
	7	0/180%		
	8	0/815 Volts		
	9	0/100%		
	10	1/180 degs		
	12	0/1		
T068	[Opto Out Logic]	0/1	1	0
	T068 Option	Opto Out Logic		
	0	NO (Normally Open)		
	1	NC (Normally Closed)		
T069	[Analog In 1 Sel]	0/6	1	2
	T069 Option	Setting	Input Range	DIP Switch A11 Setting
	0	Current Mode	0-20 mA	0-10V
	1	Current Mode	4-20 mA	0-10V
	2	Voltage Mode - Unipolar	0-10V	0-10V
	4	Current Mode (Square Root)	0-20 mA	0-10V
	5	Current Mode (Square Root)	4-20 mA	0-10V
	6	Voltage Mode - Unipolar (Square Root)	0-10V	0-20 mA
T070	[Analog In 1 Lo]	0.0/100.0%	0.1%	0.0%
T074	[Analog In 2 Lo]			
T071	[Analog In 1 Hi]	0.0/100.0%	0.1%	100.0%
T075	[Analog in 2 Hi]			
T072	[Analog In 1 Loss]	0/6	0 = "Disabled" 1 = "Fault (F29)" 2 = "Stop"	3 = "Zero Ref" 4 = "Min Freq Ref" 5 = "Max Freq Ref" 6 = "Int Freq Ref"
T076	[Analog In 2 Loss]			
T073	[Analog In 2 Sel]	0/7	1	2
	T073 Option	Setting	Input Range	DIP Switch A11 Setting
	0	Current Mode	0-20 mA	20 mA
	1	Current Mode	4-20 mA	20 mA
	2	Voltage Mode - Unipolar	0-10V	10V
	3	Voltage Mode - Bipolar	-10 to +10V	10V
	4	Current Mode (Square Root)	0-20 mA	20 mA
	5	Current Mode (Square Root)	4-20 mA	20 mA
	6	Voltage Mode - Unipolar (Square Root)	0-10V	10V
	7	Voltage Mode - Bipolar (Square Root)	-10 to +10V	10V
T077	[Sleep-Wake Sel]	0/3	0 = "Disabled" 1 = "Analog In 1"	2 = "Analog In 2" 3 = "Command Freq"
T078	[Sleep Level]	0.0/100.0%	0.1%	10.0%
T079	[Sleep Time]	0.0/600.0 Secs	0.1 Secs	0.0 Secs
T080	[Wake Level]	0.0/100.0%	0.1%	15.0%
T081	[Wake Time]	0.0/600.0 Secs	0.1 Secs	0.0 Secs

No.	Parameter	Min/Max	Display/Options	Default				
T082 T085	[Analog Out1 Sel] [Analog Out2 Sel]	0/20	1	0 1				
	Setting	Output Range	Min. Output Value	Max. Output Value	Filter	DIP Switch AO1	Related Parameter	
	0	OutFreq 0-10	0V = 0 Hz	[Maximum Frequency]	None	10V	b001	
	1	OutCurr 0-10	0V = 0 Amps	200% Drive Rated FLA	Filter A	10V	b003	
	2	OutTorq 0-10	0V = 0 Amps	200% Drive Rated FLA	Filter A	10V	b013	
	3	OutVolt 0-10	0V = 0 Volts	120% Drive Rated Output V	None	10V	b004	
	4	OutPowr 0-10	0V = 0 kW	200% Drive Rated Power	Filter A	10V	b010	
	5	Setpnt 0-10	0V = 0.0%	100.0% Setting	None	10V	T084	
	6	TstData 0-10	0V = 0000	65535 (Hex FFFF)	None	10V	A196	
	7	OutFreq 0-20	0-20 mA	0 mA = 0 Hz	[Maximum Frequency]	None	20 mA	b001
	8	OutCurr 0-20	0-20 mA	0 mA = 0 Amps	200% Drive Rated FLA	Filter A	20 mA	b003
	9	OutTorq 0-20	0-20 mA	0 mA = 0 Amps	200% Drive Rated FLA	Filter A	20 mA	b013
	10	OutVolt 0-20	0-20 mA	0 mA = 0 Volts	120% Drive Rated Output V	None	20 mA	b004
	11	OutPowr 0-20	0-20 mA	0 mA = 0 kW	200% Drive Rated Power	Filter A	20 mA	b010
	12	Setpnt 0-20	0-20 mA	0 mA = 0.0%	100.0% Setting	None	20 mA	T084
	13	TstData 0-20	0-20 mA	0 mA = 0000	65535 (Hex FFFF)	None	20 mA	A196
	14	OutFreq 4-20	4-20 mA	4 mA = 0 Hz	[Maximum Frequency]	None	20 mA	b001
	15	OutCurr 4-20	4-20 mA	4 mA = 0 Amps	200% Drive Rated FLA	Filter A	20 mA	b003
	16	OutTorq 4-20	4-20 mA	4 mA = 0 Amps	200% Drive Rated FLA	Filter A	20 mA	b013
	17	OutVolt 4-20	4-20 mA	4 mA = 0 Volts	120% Drive Rated Output V	None	20 mA	b004
	18	OutPowr 4-20	4-20 mA	4 mA = 0 kW	200% Drive Rated Power	Filter A	20 mA	b010
	19	Setpnt 4-20	4-20 mA	4 mA = 0.0%	100.0% Setting	None	20 mA	T084
	20	TstData 4-20	4-20 mA	4 mA = 0000	65535 (Hex FFFF)	None	20 mA	A196
T083 T086	[Analog Out1 High] [Analog Out2 High]	0/800%	1%	100%				
	T083 Setting	T082 Setting	T082 Max. Output Value					
	50%	1 "OutCurr 0-10"	5V for 200% Drive Rated Output Current					
	90%	11 "OutPowr 0-20"	18 mA for 200% Drive Rated Power					
T084 T087	[Anlg Out1 Setpt] [Anlg Out2 Setpt]	0.0/100.0%	0.1%	0.0%				
T088	[Anlg Loss Delay]	0.0/20.0 Secs	0.1 Secs	0.0 Secs				

Communications Group Parameters

No.	Parameter	Min/Max	Display/Options	Default
C101	[Language]	1/10	1 = "English" 2 = "Français" 3 = "Español" 4 = "Italiano" 5 = "Deutsch" 6 = "Reserved" 7 = "Português" 8 = "Reserved" 9 = "Reserved" 10 = "Nederlands"	1
C102	[Comm. Format] Power to drive must be cycled before any changes will affect drive operation.	0/9	0 = "RTU 8-N-1" 1 = "RTU 8-E-1" 2 = "RTU 8-O-1" 3 = "RTU 8-N-2" 4 = "RTU 8-E-2" 5 = "RTU 8-O-2" 6 = "MetaSys N2" 7 = "P1 8-N-1" 8 = "P1 8-E-1" 9 = "P1 8-O-1"	0
C103	[Comm Data Rate]	0/5	0 = "1200" 1 = "2400" 2 = "4800" 3 = "9600" 4 = "19.2K" 5 = "38.4K"	0
C104	[Comm Node Addr]	1/247	1	100
C105	[Comm Loss Action]	0/5	0 = "Fault" 1 = "Coast Stop" 2 = "Stop" 3 = "Continu Last" 4 = "Run Preset 0" 5 = "Kypd Inc/Dec"	0
C106	[Comm Loss Time]	0.1/60.0 Secs	0.1 Secs	5.0 Secs
C107	[Comm Write Mode]	0/1	0 = "Save" 1 = "RAM Only"	0
C108	[Start Source 2]  Sets the control scheme used to start the drive when in Auto/Remote mode.	0/6	0 = "Keypad" 1 = "3-Wire" 2 = "2-Wire" 3 = "2-W Lvl Sens" 4 = "2-W Hi Speed" 5 = "Comm Port" 6 = "2-W Lvl/Enbl"	3
C109	[Speed Ref 2]	0/5	0 = "Drive Keypad" 1 = "InternalFreq" 2 = "Analog In 1" 3 = "Analog In 2" 4 = "Preset Freq" 5 = "Comm Port"	2

Advanced Program Group Parameters

No.	Parameter	Min/Max	Display/Options	Default	
A141	[Purge Frequency]	0.0/320.0 Hz	0.1 Hz	5.0 Hz	
A142	[Internal Freq]	0.00/320.00 Hz	0.01 Hz	60.00 Hz	
A143	[Preset Freq 0]	0.0/320.0 Hz	0.1 Hz	0.0 Hz	
A144	[Preset Freq 1]			5.0 Hz	
A145	[Preset Freq 2]			10.0 Hz	
A146	[Preset Freq 3]			20.0 Hz	
A147	[Accel Time 2]	0.00/600.00 Secs	0.01 Secs	30.00 Secs	
A148	[Decel Time 2]	0.00/600.00 Secs	0.01 Secs	30.00 Secs	
A149	[S Curve %]	0/100%	1%	20%	
A150	[PID Trim Hi]	0.0/320.0 Hz	0.1 Hz	60.0 Hz	
A151	[PID Trim Lo]	0.0/320.0 Hz	0.1 Hz	0.0 Hz	
A152	[PID Ref Sel]	0/8	0 = "PID Disabled" 1 = "PID Setpoint" 2 = "Analog In 1" 3 = "Analog In 2"	4 = "Comm Port" 5 = "Setptn, Trim" 6 = "A-In 1, Trim" 7 = "A-In 2, Trim" 8 = "Comm, Trim"	0
A153	[PID Feedback Sel]	0/2	0 = "Analog In 1" 1 = "Analog In 2"	2 = "Comm Port"	0
A154	[PID Prop Gain]	0.00/99.99	0.01	1.00	
A155	[PID Integ Time]	0.0/999.9 Secs	0.1 Secs	2.0 Secs	
A156	[PID Diff Rate]	0.00/99.99 (1/Secs)	0.01 (1/Secs)	0.00 (1/Secs)	
A157	[PID Setpoint]	0.0/100.0%	0.1%	0.0%	
A158	[PID Deadband]	0.0/10.0%	0.1%	0.0%	
A159	[PID Preload]	0.0/320.0 Hz	0.1 Hz	0.0%	
A160	[Process Factor]	0.1/999.9	0.1	30.0	
A163	[Auto Rstrt Tries]	0/9	1	0	
A164	[Auto Rstrt Delay]	0.0/160.0 Secs	0.1 Secs	1.0 Secs	
A165	[Start At PowerUp]	0/1	0 = "Disabled" 1 = "Enabled"	0	
A166	[Reverse Disable]	0/1	0 = "Rev Enabled" 1 = "Rev Disabled"	1	
A167	[Flying Start En]	0/1	0 = "Disabled" 1 = "Enabled"	0	
A168	[PWM Frequency]	2.0/8.0, 10.0 kHz	0.1 kHz	4.0 kHz	
A169	[PWM Mode]	0/1	0 = "Space Vector" 1 = "2-Phase"	1	
A170	[Boost Select]	0/15	Settings in % of base voltage. 0 = "Custom V/Hz" <u>Variable Torque</u> 1 = "30.0, VT" 2 = "35.0, VT" 3 = "40.0, VT" 4 = "45.0, VT"	4	
			<u>Constant Torque</u> 5 = "0.0, no IR" 6 = "0.0" 7 = "2.5, CT" 8 = "5.0, CT" 9 = "7.5, CT"	10 = "10.0, CT" 11 = "12.5, CT" 12 = "15.0, CT" 13 = "17.5, CT" 14 = "20.0, CT" 15 = "Kepco"	
A171	[Start Boost]	0.0/25.0%	1.1%	2.5%	
		Only active when A084 [Boost Select] and A125 [Torque Perf Mode] are set to "0".			
A172	[Break Voltage]	0.0/100.0%	0.1%	25.0%	
		Only active when A084 [Boost Select] and A125 [Torque Perf Mode] are set to "0".			
A173	[Break Frequency]	0.0/320.0 Hz	0.1 Hz	15.0 Hz	
		Only active when A084 [Boost Select] and A125 [Torque Perf Mode] are set to "0".			
A174	[Maximum Voltage]	20/Rated Volts	1 VAC	Rated Volts	
A175	[Slip Hertz @ FLA]	0.0/10.0 Hz	0.1 Hz	2.0 Hz	
A176	[DC Brake Time]	0.0/99.9 Secs	0.1 Secs	0.0 Secs	
A177	[DC Brake Level]	0.0/(Drive Amps × 1.5)	0.1 Amps	Amps × 0.05	
A178	[DC Brk Time@Strt]	0.0/99.9 Secs	0.1 Secs	0.0 Secs	
A179	[Current Limit 1]	0.0/(Drive Amps × 1.5)	0.1 Amps	Amps × 1.1	
A180	[Current Limit 2]				
A181	[Motor OL Select]	0/2	0 = "No Derate" 1 = "Min Derate" 2 = "Max Derate"	0	

No.	Parameter	Min/Max	Display/Options	Default
A182	[Drive OL Mode]	0/3	0 = "Disabled" 1 = "Reduce CLim"	2 = "Reduce PWM" 3 = "Both-PWM 1st" 3
A183	[SW Current Trip]	0.0/(Drive Amps × 1.8)	0.1 Amps	0.0 (Disabled)
A184	[Load Loss Level]	0.0/Drive Amps	0.1 Amps	0.0 (Disabled)
A185	[Load Loss Time]	0/9999 Secs	1 Secs	0 (Disabled)
A186	[Stall Fault Time]	0/5	0 = "60 Seconds" 1 = "120 Seconds" 2 = "240 Seconds"	3 = "360 Seconds" 4 = "480 Seconds" 5 = "Fit Disabled" 0
A187	[Bus Reg Mode]	0/1	0 = "Disabled"	1 = "Enabled" 1
A188	[Skip Frequency 1]	0/320 Hz	1 Hz	0 Hz
A189	[Skip Freq Band 1]	0.0/30.0 Hz	0.1 Hz	0.0 Hz
A190	[Skip Frequency 2]	0/320 Hz	1 Hz	0 Hz
A191	[Skip Freq Band 2]	0.0/30.0 Hz	0.1 Hz	0.0 Hz
A192	[Skip Frequency 3]	0/320 Hz	1 Hz	0 Hz
A193	[Skip Freq Band 3]	0.0/30.0 Hz	0.1 Hz	0.0 Hz
A194	[Compensation]	0/3	0 = "Disabled" 1 = "Electrical"	2 = "Mechanical" 3 = "Both" 3
A195	[Reset Meters]	0/2	0 = "Ready/Idle"	1 = "Reset MWh" 2 = "Reset Time" 0
A196	[Testpoint Sel]	1024/65535	1	1024
A197	[Fault Clear]	0/2	0 = "Ready/Idle"	1 = "Reset Fault" 2 = "Clear Buffer" 0
A198	[Program Lock]	0/3	0 = "Unlocked" 1 = "Locked" (All)	2 = "Locked" (Not Network) 3 = "Locked" (P035, A170) 0
A199	[Motor NP Poles]	2/40	1	4
A200	[Motor NP FLA]	0.1/(Drive Amps × 2)	0.1 Amps	Rated Amps

Aux Relay Card Group Parameters

No.	Parameter	Min/Max	Display/Options	Default
R221	[Relay Out3 Sel]	0/23	0 = "Ready/Fault"	9 = "Above Anlg 2" 0
R224	[Relay Out4 Sel]		1 = "At Frequency"	10 = "Above PF Ang"
R227	[Relay Out5 Sel]		2 = "MotorRunning"	11 = "Anlg In Loss"
R230	[Relay Out6 Sel]		3 = "Hand Active"	12 = "ParamControl"
R233	[Relay Out7 Sel]		4 = "Motor Overld"	13 = "Retries Exst"
R236	[Relay Out8 Sel]		5 = "Ramp Reg"	14 = "NonRec Fault"
			6 = "Above Freq"	15 = "Reverse"
			7 = "Above Cur"	16 = "Logic In 1"
			8 = "Above DCVolt"	17 = "Logic In 2"
				23 = "Aux Motor"
R222	[Relay Out3 Level]	0.0/9999 Hz	0.1	0.0
R225	[Relay Out4 Level]			
R228	[Relay Out5 Level]			
R231	[Relay Out6 Level]			
R234	[Relay Out7 Level]			
R237	[Relay Out8 Level]			
	[Relay OutX Select] Setting	[Relay OutX Level] Min/Max		
	6	0/320 Hz		
	7	0/180%		
	8	0/815 Volts		
	9	0/100%		
	10	1/180 degs		
	12	0/1		
R239	[Aux Motor Mode]	0/1	0 = "Disabled"	1 = "Enabled" 0
R240	[Aux Motor Qty]	1/6	1 = "1 Aux Mtr" 2 = "2 Aux Mtr" 3 = "3 Aux Mtr"	4 = "1 Mtr + Swap" 5 = "2 Mtr + Swap" 6 = "3 Mtr + Swap" 1
R241	[Aux 1 Start Freq]	0.0/320.0 Hz	0.1 Hz	50.0 Hz
R244	[Aux 2 Start Freq]			
R247	[Aux 3 Start Freq]			

No.	Parameter	Min/Max	Display/Options	Default
R242	[Aux 1 Stop Freq]	0.0/320.0 Hz	0.1 Hz	25.0 Hz
R245	[Aux 2 Stop Freq]			
R248	[Aux 3 Stop Freq]			
R243	[Aux 1 Ref Add]	0.0/100.0%	0.1%	0.0%
R246	[Aux 2 Ref Add]			
R249	[Aux 3 Ref Add]			
R250	[Aux Start Delay]	0.0/999.9 Secs	0.1 Secs	5.0 Secs
R251	[Aux Stop Delay]	0.0/999.9 Secs	0.1 Secs	3.0 Secs
R252	[Aux Prog Delay]	0.00/60.00 Secs	0.01 Secs	0.50 Secs
R253	[Aux AutoSwap Tme]	0.0/999.9 Hrs	0.1 Hrs	0.0 Hr
R254	[Aux AutoSwap Lvl]	0.0/100.0%	0.1%	50.0%

Advanced Display Group Parameters

No.	Parameter	Min/Max	Display/Options	Default																								
d301	[Control Source]	0/99	Digit 0: Start Command 0 = Keypad 1 = Terminal Block 2 = Communications Digit 1: Speed Command 0 = Local Keypad Pot 1 = A142 2 = Analog Input 1 3 = Analog Input 2 4 = A143-146 5 = Communications	Read Only																								
d302	[Control In Status]	0/1 (1 = Condition True)	<table border="1"> <thead> <tr> <th>Display Digit (Right to Left)</th> <th>I/O Terminal</th> <th>Control Input</th> </tr> </thead> <tbody> <tr> <td>0</td> <td>02</td> <td>Start/FWD In</td> </tr> <tr> <td>1</td> <td>03</td> <td>Dir/Rev In</td> </tr> <tr> <td>2</td> <td>01</td> <td>Stop Input</td> </tr> <tr> <td>3</td> <td>05</td> <td>Digital In 1</td> </tr> <tr> <td>4</td> <td>06</td> <td>Digital In 2</td> </tr> <tr> <td>5</td> <td>07</td> <td>Digital In 3</td> </tr> <tr> <td>6</td> <td>08</td> <td>Digital In 4</td> </tr> </tbody> </table>	Display Digit (Right to Left)	I/O Terminal	Control Input	0	02	Start/FWD In	1	03	Dir/Rev In	2	01	Stop Input	3	05	Digital In 1	4	06	Digital In 2	5	07	Digital In 3	6	08	Digital In 4	Read Only
Display Digit (Right to Left)	I/O Terminal	Control Input																										
0	02	Start/FWD In																										
1	03	Dir/Rev In																										
2	01	Stop Input																										
3	05	Digital In 1																										
4	06	Digital In 2																										
5	07	Digital In 3																										
6	08	Digital In 4																										
d303	[Comm Status]	0/1 (1 = Condition True)	Digit 0: Received Good Message Packet Digit 1: Transmitting Message Digit 2: DSI Peripheral Connected Digit 3: Received Bad Message Packet	Read Only																								
d304	[PID Setpnt Displ]	0.0/100.0%	0.1%	0.0%																								
d305	[Analog In 1]	0.0/120.0%	0.1%	0.0%																								
d306	[Analog In 2]																											
d307	[Fault 1 Code]	0/122	1	Read Only																								
d308	[Fault 2 Code]																											
d309	[Fault 3 Code]																											
d310	[Fault 1 Time-hr]	0/9999 Hrs	1 Hrs	Read Only																								
d312	[Fault 2 Time-hr]																											
d314	[Fault 3 Time-hr]																											
d311	[Fault 1 Time-min]	0.0/60.0 Min	0.1 Min	Read Only																								
d313	[Fault 2 Time-min]																											
d315	[Fault 3 Time-min]																											
d316	[Elapsed Time-hr]	0/32767	1 Hr	Read Only																								
d317	[Elapsed Time-min]	0.0/60.0 Min	0.1 Min	Read Only																								
d318	[Output Powr Fctr]	0.0/180.0 deg	0.1 deg	Read Only																								
d319	[Testpoint Data]	0/FFFF	1 Hex	Read Only																								
d320	[Control SW Ver]	1.00/99.99	0.01	Read Only																								
d321	[Drive Type]	Used by Rockwell Automation field service personnel.																										
d322	[Output Speed]	0.0/100.0%	0.1%	Read Only																								
d323	[Output RPM]	0/24000 RPM	1 RPM	Read Only																								
d324	[Fault Frequency]	0.00/320.00 Hz	0.01 Hz	Read Only																								
d325	[Fault Current]	0.0/(Drive Amps × 2)	0.1 Amps	Read Only																								
d326	[Fault Bus Volts]	0/820 VDC	1 VDC	Read Only																								
d327	[Status @ Fault]	0/1	1	Read Only																								

Fault Codes

To clear a fault, press the Stop key, cycle power or set A100 [Fault Clear] to 1 or 2.

No.	Fault	Description
F2	Auxiliary Input ⁽¹⁾	Check remote wiring.
F3	Power Loss	Monitor the incoming AC line for low voltage or line power interruption.
F4	UnderVoltage ⁽¹⁾	Monitor the incoming AC line for low voltage or line power interruption.
F5	OverVoltage ⁽¹⁾	Monitor the AC line for high line voltage or transient conditions. Bus overvoltage can also be caused by motor regeneration. Extend the decel time or install a dynamic brake chopper.
F6	Motor Stalled ⁽¹⁾	Increase [Accel Time x] or reduce load so drive output current does not exceed the current set by parameter A089 [Current Limit].
F7	Motor Overload ⁽¹⁾	An excessive motor load exists. Reduce load so drive output current does not exceed the current set by parameter P033 [Motor OL Current].
F8	Heatsink OvrTemp ⁽¹⁾	Check for blocked or dirty heat sink fins. Verify that ambient temperature has not exceeded 40°C (104°F) for IP 30/NEMA 1/UL Type 1 installations or 50°C (122°F) for Open type installations. Check fan.
F12	HW OverCurrent	Check programming. Check for excess load, improper DC boost setting, DC brake volts set too high or other causes of excess current.
F13	Ground Fault	Check the motor and external wiring to the drive output terminals for a grounded condition.
F15	Load Loss	Check for load loss (i.e., a broken belt).
F29	Analog Input Loss ⁽¹⁾	An analog input is configured to fault on signal loss. A signal loss has occurred.
F33	Auto Rstrt Tries	Correct the cause of the fault and manually clear.
F38	Phase U to Gnd	Check the wiring between the drive and motor. Check motor for grounded phase.
F39	Phase V to Gnd	Replace drive if fault cannot be cleared.
F40	Phase W to Gnd	
F41	Phase UV Short	Check the motor and drive output terminal wiring for a shorted condition.
F42	Phase UW Short	Replace drive if fault cannot be cleared.
F43	Phase VW Short	
F48	Params Defaulted	The drive was commanded to write default values to EEPROM. Clear the fault or cycle power to the drive. Program the drive parameters as needed.
F63	SW OverCurrent ⁽¹⁾	Check load requirements and A098 [SW Current Trip] setting.
F64	Drive Overload	Reduce load or extend Accel Time.
F70	Power Unit	Cycle power. Replace drive if fault cannot be cleared.
F71	Net Loss	The communication network has faulted.
F81	Comm Loss	If adapter was not intentionally disconnected, check wiring to the port. Replace wiring, port expander, adapters or complete drive as required. Check connection. An adapter was intentionally disconnected. Turn off using C105 [Comm Loss Action].
F94	Function Loss	Close input to terminal 01 and re-start the drive.
F100	Parameter Checksum	Restore factory defaults.
F122	I/O Board Fail	Cycle power. Replace drive if fault cannot be cleared.

⁽¹⁾ Auto-Reset/Run type fault. Configure with parameters A092 and A093.

For a complete listing of Faults and Alarms, refer to the PowerFlex 400 *User Manual*.

Dimensions

PowerFlex 400 Frames

Output Power		Frame Size	
kW	HP	208-240V AC Input	400-480V AC Input
2.2-7.5	3-10	C	C
11-15	15-20	D	C
18.5-22	25-30	D	D
30-37	40-50	E	E
45-75	60-100	-	E
90-110	125-150	-	F

Figure 5: PowerFlex 400 Frames C-F

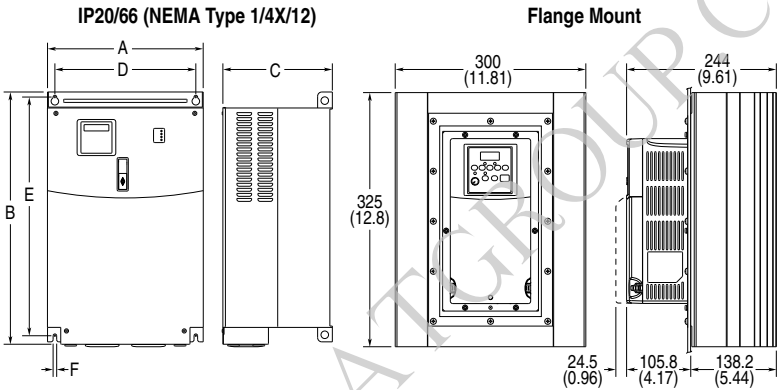

Dimensions are in millimeters and (inches).

Frame	A	B	C	D	E	F	Weight ⁽¹⁾ kg (lbs.)
C	130.0 (5.1)	260.0 (10.2)	180.0 (7.1)	116.0 (4.57)	246.0 (9.7)	5.8 (0.23)	4.33 (9.5)
D	250.0 (9.84)	436.2 (17.17)	206.1 (8.11)	226.0 (8.90)	383.4 (15.09)	9.0 (0.35)	14.0 (30.9)
E	370.0 (14.57)	605.5 (23.84)	259.2 (10.21)	335.0 (13.19)	567.4 (22.34)	8.5 (0.33)	51.2 (112.9)
F	425.0 (16.73)	850.0 (33.46)	264.0 (10.39)	381.0 (15.00)	647.5 (25.49)	13.0 (0.51)	88.0 (194.0)

(1) Weights include HIM and Standard I/O.

EMC Line Filters

Figure 6: Catalog Numbers: 22-RF018-CS, 22-RF018-CL, 22-RF026-CS, 22-RF026-CL, 22-RF034-CS

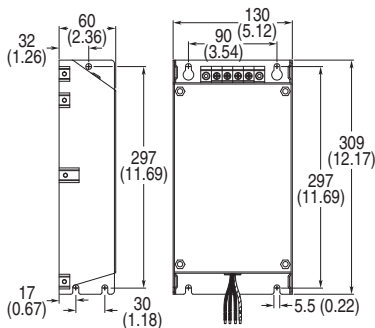
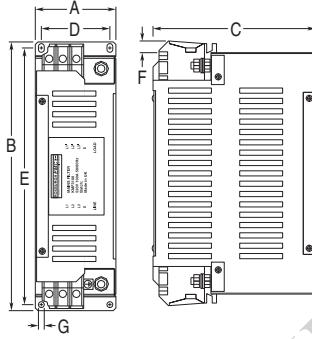

Figure 7: Catalog Numbers: 22-RFD036, 22-RFD050, 22-RFD070, 22-RFD100, 22-RFD150, 22-RFD180



Catalog Number	A	B	C	D	E	F	G
22-RFD036	74 (2.91)	272 (10.71)	161 (6.34)	60 (2.36)	258 (10.16)	7.5 (0.30)	7 (0.28)
22-RFD050	93 (3.66)	312 (12.28)	190 (7.48)	79 (3.11)	298 (11.73)	13.5 (0.53)	7 (0.28)
22-RFD070	93 (3.66)	312 (12.28)	190 (7.48)	79 (3.11)	298 (11.73)	13.5 (0.53)	7 (0.28)
22-RFD100	93 (3.66)	312 (12.28)	190 (7.48)	79 (3.11)	298 (11.73)	13.5 (0.53)	7 (0.28)
22-RFD150	126 (4.96)	312 (12.28)	224 (8.82)	112 (4.41)	298 (11.73)	19.5 (0.77)	7 (0.28)
22-RFD180	126 (4.96)	312 (12.28)	224 (8.82)	112 (4.41)	298 (11.73)	27 (1.06)	7 (0.28)

Dimensions are in millimeters and (inches).

Figure 8: Catalog Numbers: 22-RFD330

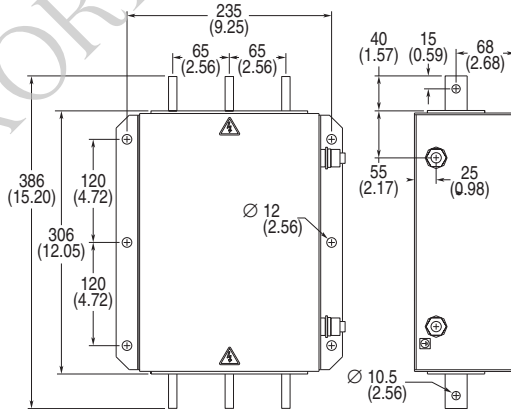

WWW.KORATGROUP.COM

www.rockwellautomation.com

Power, Control and Information Solutions Headquarters

Americas: Rockwell Automation, 1201 South Second Street, Milwaukee, WI 53204-2496 USA, Tel: (1) 414.382.2000, Fax: (1) 414.382.4444
Europe/Middle East/Africa: Rockwell Automation, Vorstlaan/Boulevard du Souverain 36, 1170 Brussels, Belgium, Tel: (32) 2 663 0600, Fax: (32) 2 663 0640
Asia Pacific: Rockwell Automation, Level 14, Core F Cyberport 3, 100 Cyberport Road, Hong Kong, Tel: (852) 2887 4788, Fax: (852) 2508 1846

Publication 22C-QS001B-EN-P – June 2013

Supersedes February 2006

Copyright © 2013 Rockwell Automation, Inc. All rights reserved.